

**DRV134**  
**DRV135**

## AUDIO BALANCED LINE DRIVERS

### FEATURES

- **BALANCED OUTPUT**
- **LOW DISTORTION: 0.0005% at  $f = 1\text{kHz}$**
- **WIDE OUTPUT SWING: 17V<sub>rms</sub> into 600 $\Omega$**
- **HIGH CAPACITIVE LOAD DRIVE**
- **HIGH SLEW RATE: 15V/ $\mu\text{s}$**
- **WIDE SUPPLY RANGE:  $\pm 4.5\text{V}$  to  $\pm 18\text{V}$**
- **LOW QUIESCENT CURRENT:  $\pm 5.2\text{mA}$**
- **8-PIN DIP, SO-8, AND SOL-16 PACKAGES**
- **COMPANION TO AUDIO DIFFERENTIAL LINE RECEIVERS: INA134 and INA137**
- **IMPROVED REPLACEMENT FOR SSM2142**

### APPLICATIONS

- **AUDIO DIFFERENTIAL LINE DRIVER**
- **AUDIO MIX CONSOLES**
- **DISTRIBUTION AMPLIFIER**
- **GRAPHIC/PARAMETRIC EQUALIZERS**
- **DYNAMIC RANGE PROCESSORS**
- **DIGITAL EFFECTS PROCESSORS**
- **TELECOM SYSTEMS**
- **HI-FI EQUIPMENT**
- **INDUSTRIAL INSTRUMENTATION**

### DESCRIPTION

The DRV134 and DRV135 are differential output amplifiers that convert a single-ended input to a balanced output pair. These balanced audio drivers consist of high performance op amps with on-chip precision resistors. They are fully specified for high performance audio applications and have excellent ac specifications, including low distortion (0.0005% at 1kHz) and high slew rate (15V/ $\mu\text{s}$ ).

The on-chip resistors are laser-trimmed for accurate gain and optimum output common-mode rejection. Wide output voltage swing and high output drive capability allow use in a wide variety of demanding applications. They easily drive the large capacitive loads associated with long audio cables. Used in combination with the INA134 or INA137 differential receivers, they offer a complete solution for transmitting analog audio signals without degradation.

The DRV134 is available in 8-pin DIP and SOL-16 surface-mount packages. The DRV135 comes in a space-saving SO-8 surface-mount package. Both are specified for operation over the extended industrial temperature range,  $-40^{\circ}\text{C}$  to  $+85^{\circ}\text{C}$  and operate from  $-55^{\circ}\text{C}$  to  $+125^{\circ}\text{C}$ .

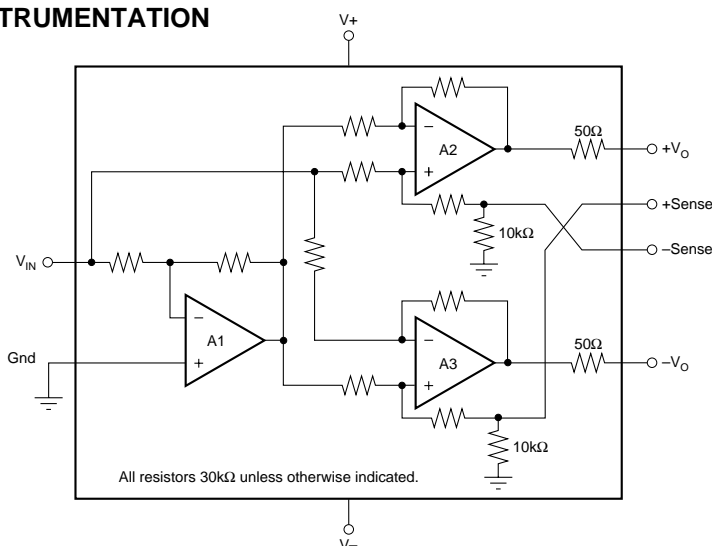

# SPECIFICATIONS: $V_S = \pm 18V$

At  $T_A = +25^\circ C$ ,  $V_S = \pm 18V$ ,  $R_L = 600\Omega$  differential connected between  $+V_O$  and  $-V_O$ , unless otherwise noted.

PARAMETER	CONDITIONS	DRV134PA, UA DRV135UA			UNITS	
		MIN	TYP	MAX		
<b>AUDIO PERFORMANCE</b>						
Total Harmonic Distortion + Noise	THD+N	f = 20Hz to 20kHz, $V_O = 10V_{rms}$ f = 1kHz, $V_O = 10V_{rms}$		0.001	%	
Noise Floor, RTO <sup>(1)</sup>		20kHz BW		-98	dBu	
Headroom, RTO <sup>(1)</sup>		THD+N < 1%		+27	dBu	
<b>INPUT</b>						
Input Impedance <sup>(2)</sup>	$Z_{IN}$			10	k $\Omega$	
Input Current	$I_{IN}$	$V_{IN} = \pm 7.07V$		$\pm 700$	$\mu A$	
<b>GAIN</b>						
Differential		$[(+V_O) - (-V_O)]/V_{IN}$ $V_{IN} = \pm 10V$				
Initial		5.8	6		dB	
Error			$\pm 0.1$	$\pm 2$	%	
vs Temperature			$\pm 10$		ppm/ $^\circ C$	
Single-Ended		$V_{IN} = \pm 5V$				
Initial		5.8	6		dB	
Error			$\pm 0.7$	$\pm 2$	%	
vs Temperature			$\pm 10$		ppm/ $^\circ C$	
Nonlinearity			0.0003		% of FS	
<b>OUTPUT</b>						
Common-Mode Rejection, f = 1kHz	OCMR	See OCMR Test Circuit, Figure 4		46	68	dB
Signal Balance Ratio, f = 1kHz	SBR	See SBR Test Circuit, Figure 5		35	54	dB
Output Offset Voltage						
Offset Voltage, Common-Mode	$V_{OCM}^{(3)}$	$V_{IN} = 0$		$\pm 50$	$\pm 250$	mV
vs Temperature				$\pm 150$		$\mu V/^\circ C$
Offset Voltage, Differential	$V_{OD}^{(4)}$	$V_{IN} = 0$		$\pm 1$	$\pm 10$	mV
vs Temperature				$\pm 5$		$\mu V/^\circ C$
vs Power Supply	PSRR	$V_S = \pm 4.5V$ to $\pm 18V$		80	110	dB
Output Voltage Swing, Positive		No Load <sup>(5)</sup>		(V+) - 3	(V+) - 2.5	V
Negative		No Load <sup>(5)</sup>		(V-) + 2	(V-) + 1.5	V
Impedance				50		$\Omega$
Load Capacitance, Stable Operation	$C_L$	$C_L$ Tied to Ground (each output)		1		$\mu F$
Short-Circuit Current	$I_{SC}$			$\pm 85$		mA
<b>FREQUENCY RESPONSE</b>						
Small-Signal Bandwidth				1.5		MHz
Slew Rate	SR			15		V/ $\mu s$
Settling Time: 0.01%		$V_{OUT} = 10V$ Step		2.5		$\mu s$
Overload Recovery		Output Overdriven 10%		3		$\mu s$
<b>POWER SUPPLY</b>						
Rated Voltage	$V_S$			$\pm 18$		V
Voltage Range		$\pm 4.5$		$\pm 18$		V
Quiescent Current	$I_Q$	$I_O = 0$		$\pm 5.2$	$\pm 5.5$	mA
<b>TEMPERATURE RANGE</b>						
Specification Range		-40			+85	$^\circ C$
Operation Range		-55			+125	$^\circ C$
Storage Range		-55			+125	$^\circ C$
Thermal Resistance	$\theta_{JA}$					
8-Pin DIP				100		$^\circ C/W$
SO-8 Surface Mount				150		$^\circ C/W$
SQL-16 Surface Mount				80		$^\circ C/W$

NOTES: (1) dBu = 20log (Vrms/0.7746). (2) Resistors are ratio matched but have  $\pm 20\%$  absolute value. (3)  $V_{OCM} = [(+V_O) + (-V_O)]/2$ . (4)  $V_{OD} = (+V_O) - (-V_O)$ . (5) Guarantees linear operation. Includes common-mode offset.

The information provided herein is believed to be reliable; however, BURR-BROWN assumes no responsibility for inaccuracies or omissions. BURR-BROWN assumes no responsibility for the use of this information, and all use of such information shall be entirely at the user's own risk. Prices and specifications are subject to change without notice. No patent rights or licenses to any of the circuits described herein are implied or granted to any third party. BURR-BROWN does not authorize or warrant any BURR-BROWN product for use in life support devices and/or systems.

## PIN CONFIGURATIONS

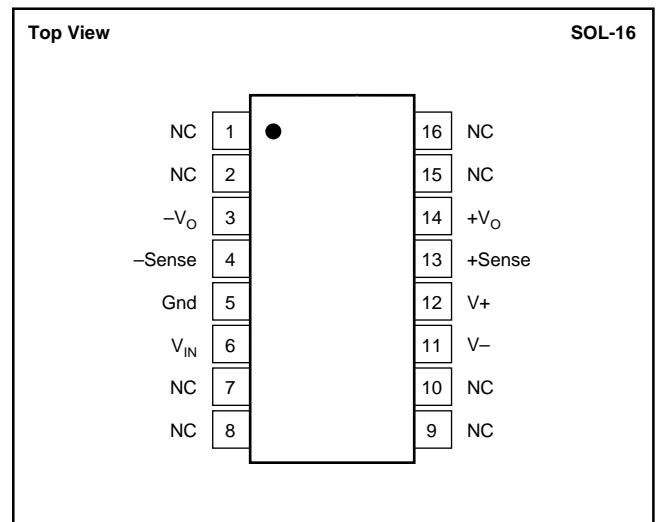
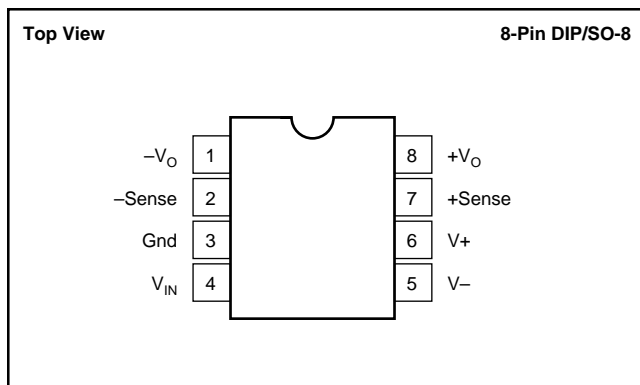

## ABSOLUTE MAXIMUM RATINGS<sup>(1)</sup>

Supply Voltage, $V_+$ to $V_-$ .....	40V
Input Voltage Range .....	$V_-$ to $V_+$
Output Short-Circuit (to ground) .....	Continuous
Operating Temperature .....	$-55^\circ\text{C}$ to $+125^\circ\text{C}$
Storage Temperature .....	$-55^\circ\text{C}$ to $+125^\circ\text{C}$
Junction Temperature .....	$+150^\circ\text{C}$
Lead Temperature (soldering, 10s) .....	$+300^\circ\text{C}$

NOTE: (1) Stresses above these ratings may cause permanent damage. Exposure to absolute maximum conditions for extended periods may affect device reliability.



## ELECTROSTATIC DISCHARGE SENSITIVITY

This integrated circuit can be damaged by ESD. Burr-Brown recommends that all integrated circuits be handled with appropriate precautions. Failure to observe proper handling and installation procedures can cause damage.

ESD damage can range from subtle performance degradation to complete device failure. Precision integrated circuits may be more susceptible to damage because very small parametric changes could cause the device not to meet its published specifications.

## PACKAGE/ORDERING INFORMATION

PRODUCT	PACKAGE	PACKAGE DRAWING NUMBER <sup>(1)</sup>	SPECIFIED TEMPERATURE RANGE	ORDERING NUMBER <sup>(2)</sup>	TRANSPORT MEDIA
DRV134PA	8-Pin DIP	006	$-40^\circ\text{C}$ to $+85^\circ\text{C}$	DRV134PA	Rails
DRV134UA	SOL-16 Surface Mount	211	$-40^\circ\text{C}$ to $+85^\circ\text{C}$	DRV134UA	Rails
"	"	"	"	DRV134UA/1K	Tape and Reel
DRV135UA	SO-8 Surface Mount	182	$-40^\circ\text{C}$ to $+85^\circ\text{C}$	DRV135UA	Rails
"	"	"	"	DRV135UA/2K5	Tape and Reel

NOTES: (1) For detailed drawing and dimension table, please see end of data sheet, or Appendix C of Burr-Brown IC Data Book. For detailed Tape and Reel mechanical information refer to Appendix B of Burr-Brown IC Data Book. (2) Models with a slash (/) are available only in Tape and Reel in the quantities indicated (e.g., /2K5 indicates 2500 devices per reel). Ordering 2500 pieces of "DRV135UA/2K5" will get a single 2500-piece Tape and Reel. For detailed Tape and Reel mechanical information, refer to Appendix B of Burr-Brown IC Data Book.

# TYPICAL PERFORMANCE CURVES

At  $T_A = +25^\circ\text{C}$ ,  $V_S = \pm 18\text{V}$ ,  $R_L = 600\Omega$  differential connected between  $+V_O$  and  $-V_O$ , unless otherwise noted.

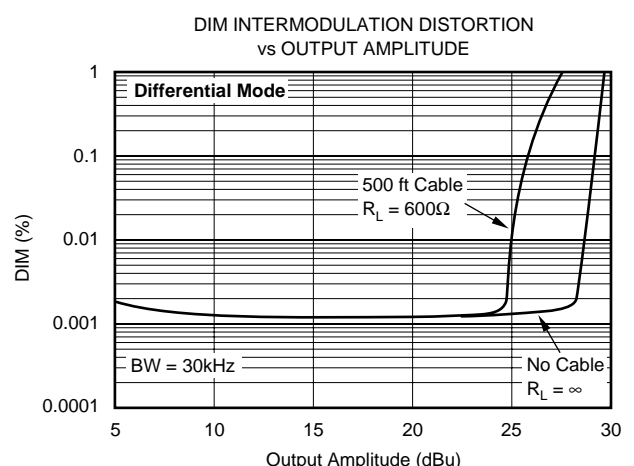
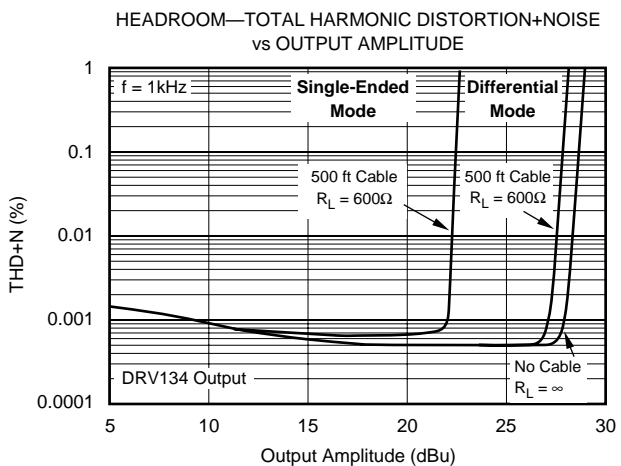
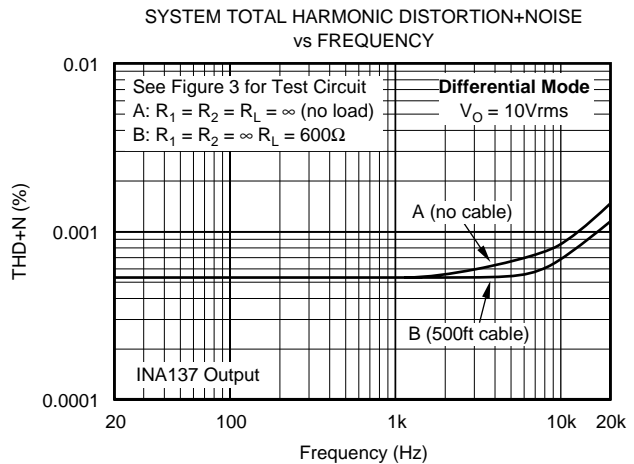
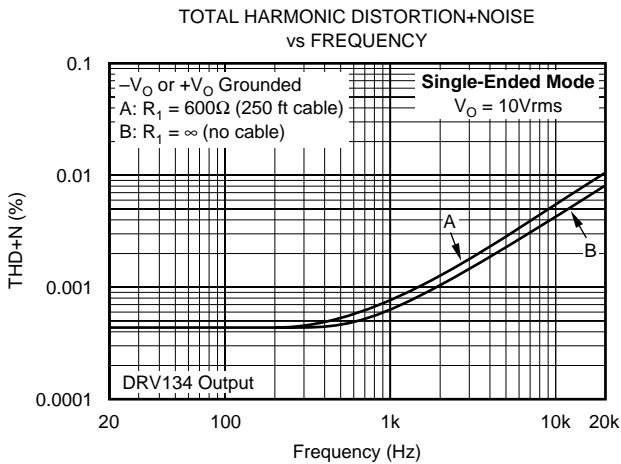
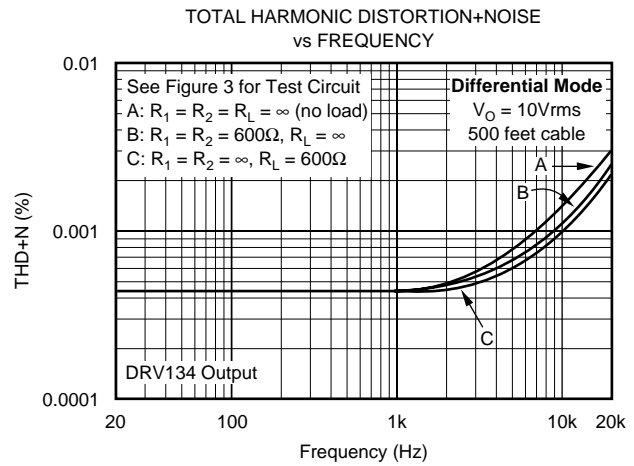
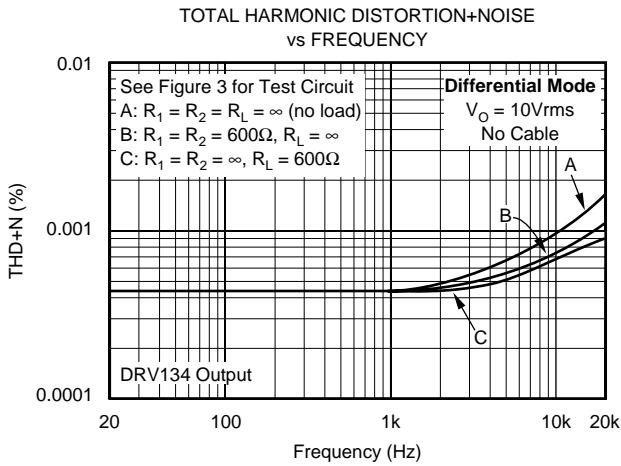

# TYPICAL PERFORMANCE CURVES (CONT)

At  $T_A = +25^\circ\text{C}$ ,  $V_S = \pm 18\text{V}$ ,  $R_L = 600\Omega$  differential connected between  $+V_O$  and  $-V_O$ , unless otherwise noted.

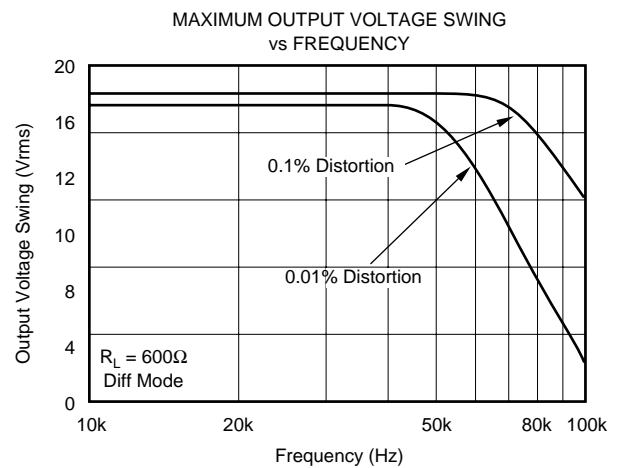
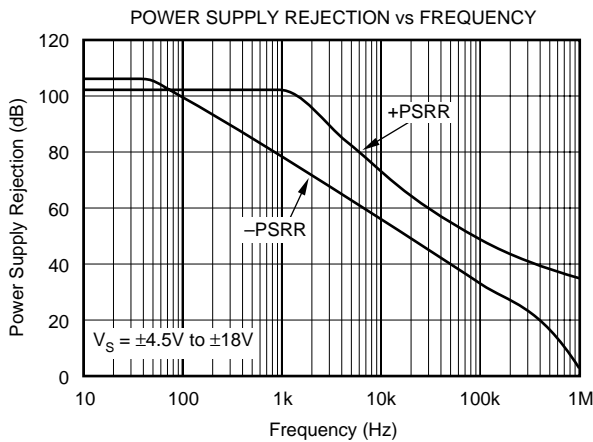
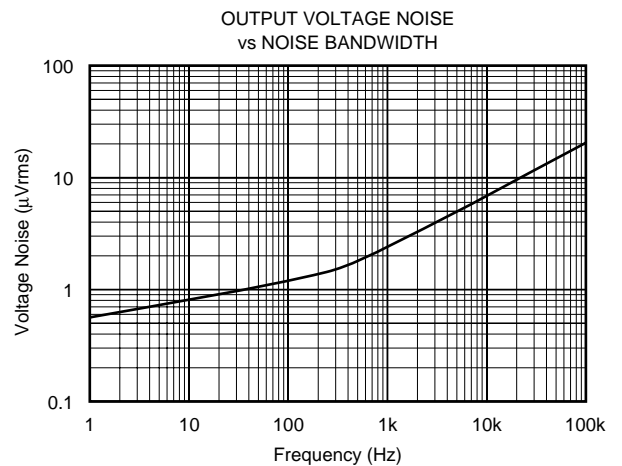
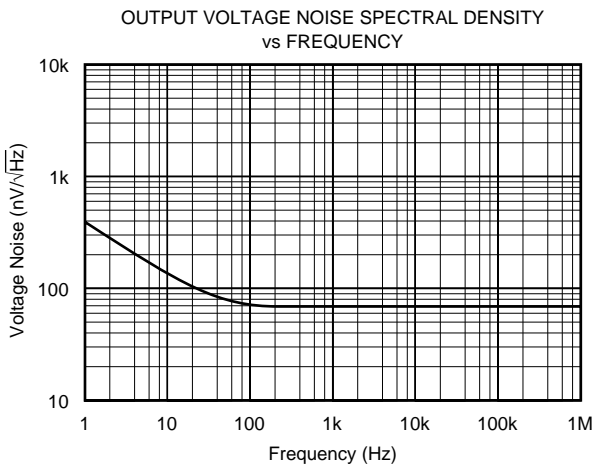
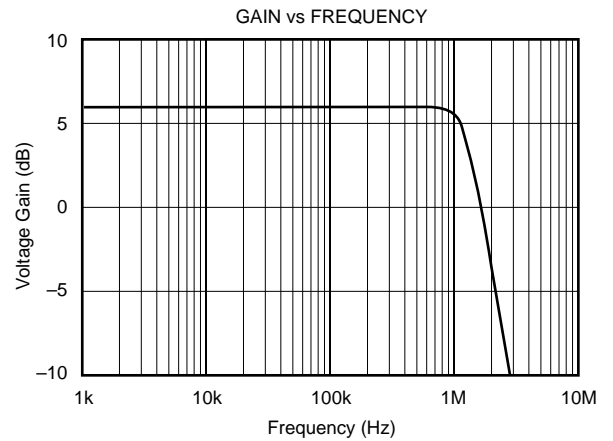
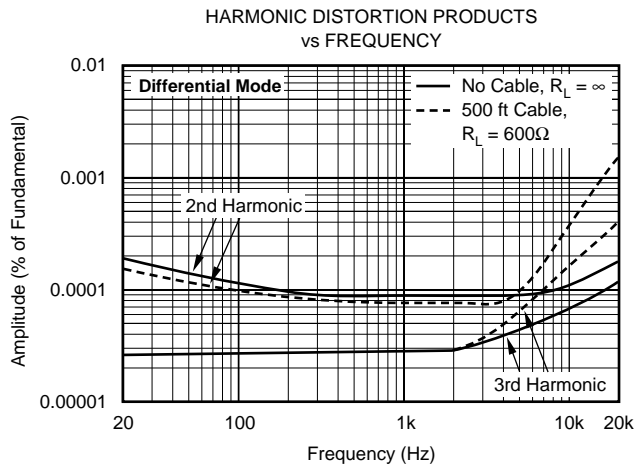

# TYPICAL PERFORMANCE CURVES (CONT)

At  $T_A = +25^\circ\text{C}$ ,  $V_S = \pm 18\text{V}$ ,  $R_L = 600\Omega$  differential connected between  $+V_O$  and  $-V_O$ , unless otherwise noted.

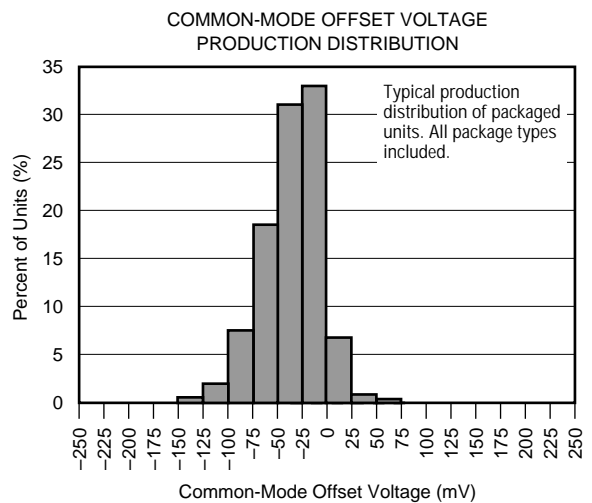
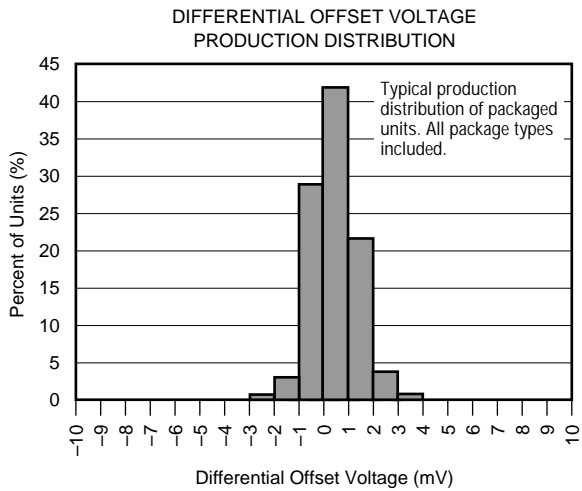
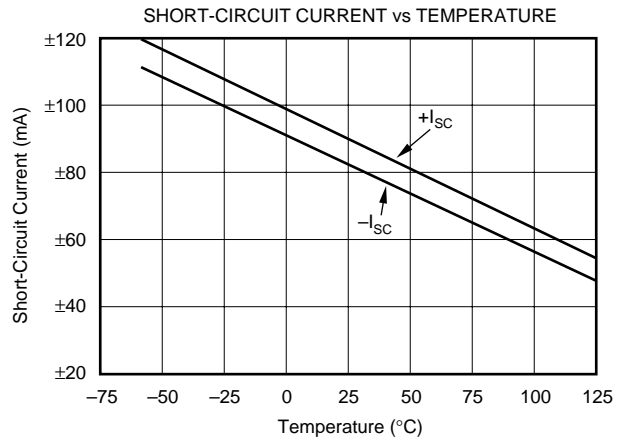
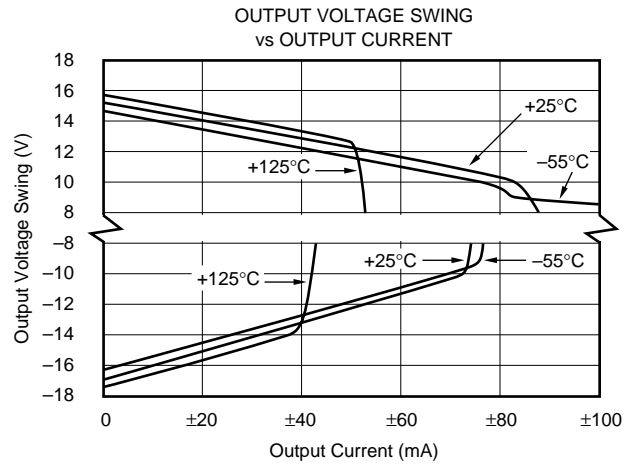
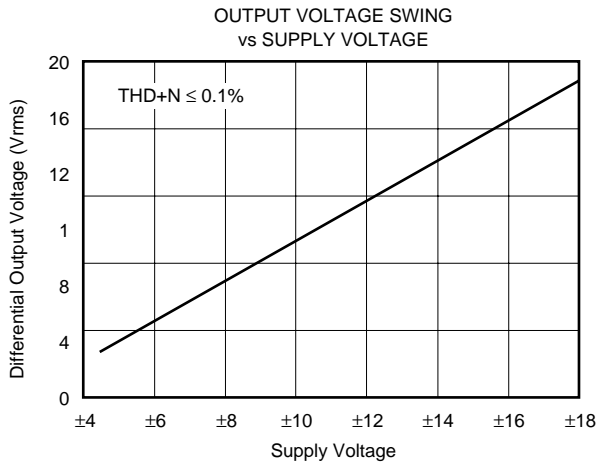

# TYPICAL PERFORMANCE CURVES (CONT)

At  $T_A = +25^\circ\text{C}$ ,  $V_S = \pm 18\text{V}$ ,  $R_L = 600\Omega$  differential connected between  $+V_O$  and  $-V_O$ , unless otherwise noted.

SMALL-SIGNAL STEP RESPONSE

$C_L = 100\text{pF}$

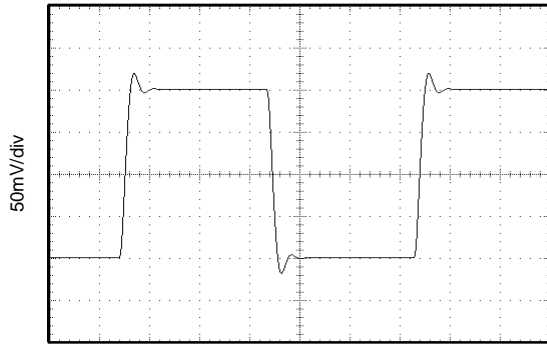

$2\mu\text{s/div}$

SMALL-SIGNAL STEP RESPONSE

$C_L = 1000\text{pF}$

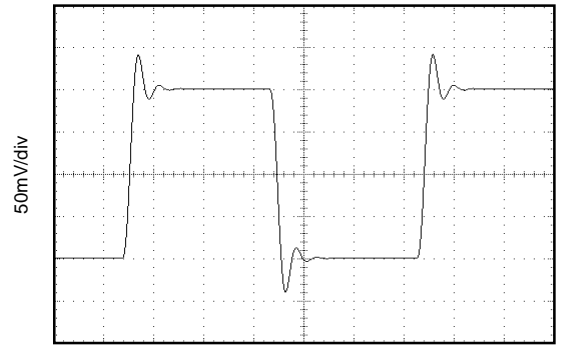

$2\mu\text{s/div}$

LARGE-SIGNAL STEP RESPONSE

$C_L = 100\text{pF}$

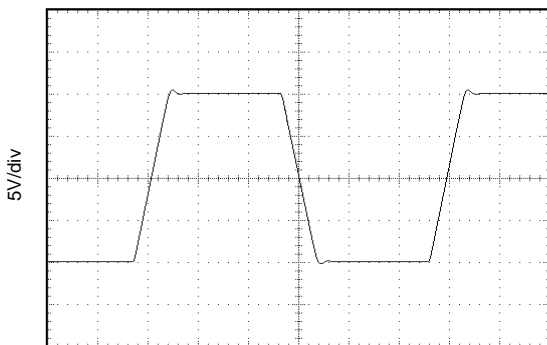

$2\mu\text{s/div}$

LARGE-SIGNAL STEP RESPONSE

$C_L = 1000\text{pF}$

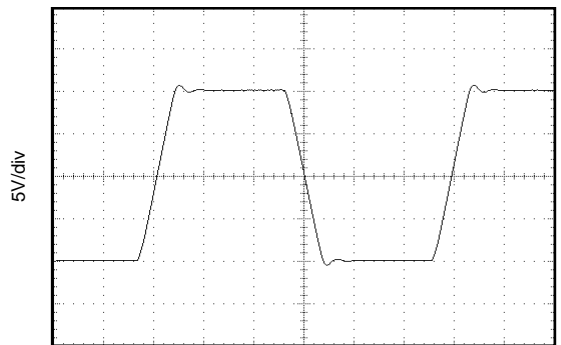

$2\mu\text{s/div}$

SMALL-SIGNAL OVERSHOOT  
vs LOAD CAPACITANCE

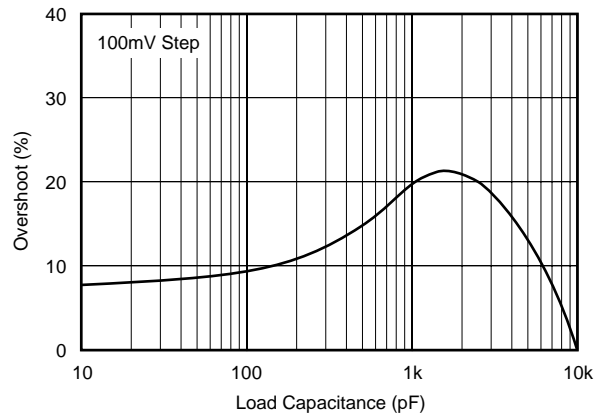



Excellent internal design and layout techniques provide low signal distortion, high output level (+27dBu), and a low noise floor (-98dBu). Laser trimming of thin film resistors assures excellent output common-mode rejection (OCMR) and signal balance ratio (SBR). In addition, low dc voltage offset reduces errors and minimizes load currents.

For best system performance, it is recommended that a high input-impedance difference amplifier be used as the receiver. Used with the INA134 ( $G = 0\text{dB}$ ) or the INA137 ( $G = \pm 6\text{dB}$ ) differential line receivers, the DRV134 forms a complete solution for driving and receiving audio signals, replacing input and output coupling transformers commonly used in professional audio systems (Figure 2). When used with the INA137 ( $G = -6\text{dB}$ ) overall system gain is unity.

### AUDIO PERFORMANCE

The DRV134 was designed for enhanced ac performance. Very low distortion, low noise, and wide bandwidth provide superior performance in high quality audio applications. Laser-trimmed matched resistors provide optimum output common-mode rejection (typically 68dB), especially when compared to circuits implemented with op amps and discrete precision resistors. In addition, high slew rate ( $15\text{V}/\mu\text{s}$ ) and fast settling time ( $2.5\mu\text{s}$  to  $0.01\%$ ) ensure excellent dynamic response.

The DRV134 has excellent distortion characteristics. As shown in the distortion data provided in the typical performance curves, THD+Noise is below 0.003% throughout the audio frequency range under various output conditions. Both differential and single-ended modes of operation are shown. In addition, the optional  $10\mu\text{F}$  blocking capacitors used to minimize  $V_{\text{OCM}}$  errors have virtually no effect on performance. Measurements were taken with an Audio Precision System One (with the internal 80kHz noise filter) using the THD test circuit shown in Figure 3.

Up to approximately 10kHz, distortion is below the measurement limit of commonly used test equipment. Furthermore, distortion remains relatively constant over the wide output voltage swing range (approximately 2.5V from the positive supply and 1.5V from the negative supply). A special output stage topology yields a design with minimum distortion variation from lot-to-lot and unit-to-unit. Furthermore, the small and large signal transient response curves demonstrate the DRV134's stability under load.

### OUTPUT COMMON-MODE REJECTION

Output common-mode rejection (OCMR) is defined as the change in differential output voltage due to a change in output common-mode voltage. When measuring OCMR,  $V_{\text{IN}}$  is grounded and a common-mode voltage,  $V_{\text{CM}}$ , is applied to the output as shown in Figure 4. Ideally no differential mode signal ( $V_{\text{OD}}$ ) should appear. However, a small mode-conversion effect causes an error signal whose magnitude is quantified by OCMR.

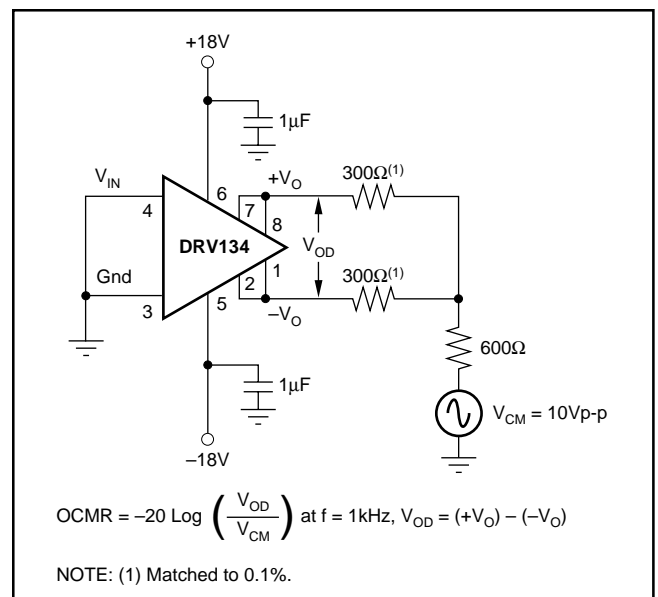

FIGURE 4. Output Common-Mode Rejection Test Circuit.

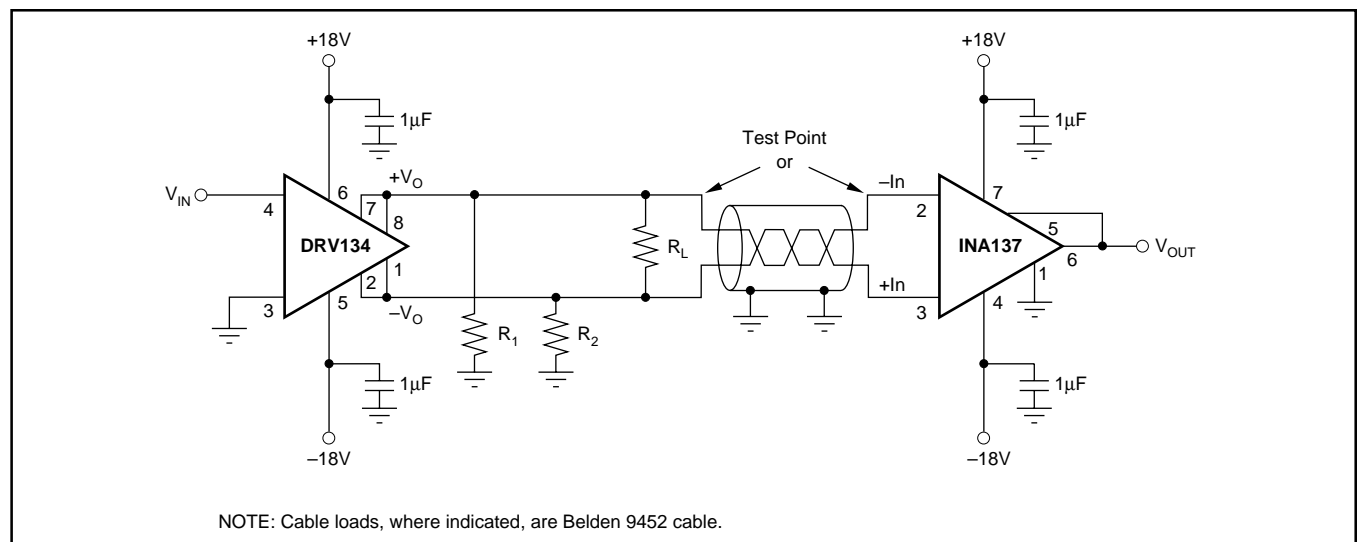

FIGURE 3. Distortion Test Circuit.

## SIGNAL BALANCE RATIO

Signal balance ratio (SBR) measures the symmetry of the output signals under loaded conditions. To measure SBR an input signal is applied and the outputs are summed as shown in Figure 5.  $V_{OUT}$  should be zero since each output ideally is exactly equal and opposite. However, an error signal results from any imbalance in the outputs. This error is quantified by SBR. The impedances of the DRV134's output stages are closely matched by laser trimming to minimize SBR errors. In an application, SBR also depends on the balance of the load network.

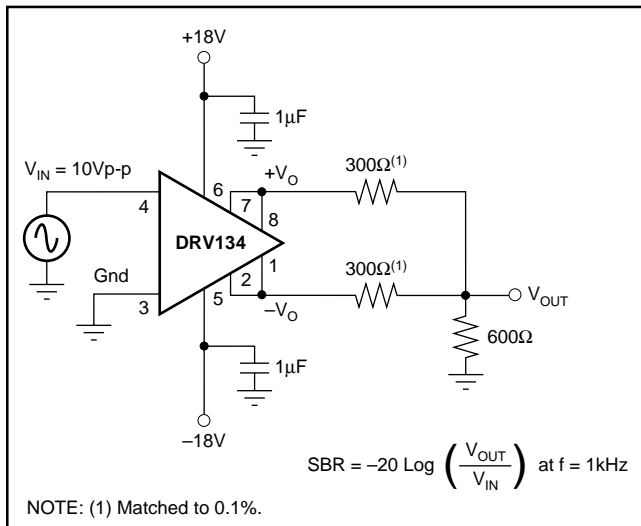

FIGURE 5. Signal Balance Ratio Test Circuit.

## SINGLE-ENDED OPERATION

The DRV134 can be operated in single-ended mode without degrading output drive capability. Single-ended operation requires that the unused side of the output pair be grounded (both the  $V_O$  and Sense pins) to a low impedance return path. Gain remains +6dB. Grounding the negative outputs as shown in Figure 6 results in a noninverted output signal ( $G = +2$ ) while grounding the positive outputs gives an inverted output signal ( $G = -2$ ).

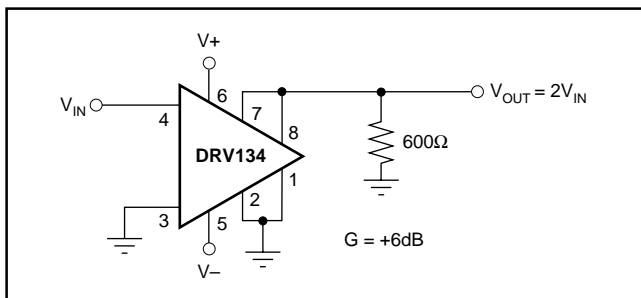

FIGURE 6. Typical Single-Ended Application.

For best rejection of line noise and hum differential mode operation is recommended. However, single-ended performance is adequate for many applications. In general single-ended performance is comparable to differential mode (see THD+N typical performance curves), but the common-mode and noise rejection inherent in balanced-pair systems is lost.

## CABLE

The DRV134 is capable of driving large signals into 600Ω loads over long cables. Low impedance shielded audio cables such as the standard Belden 8451 or 9452 (or similar) are recommended, especially in applications where long cable lengths are required.

## THERMAL PERFORMANCE

The DRV134 and DRV135 have robust output drive capability and excellent performance over temperature. In most applications there is no significant difference between the DIP, SOL-16, and SO-8 packages. However, for applications with extreme temperature and load conditions, the SOL-16 (DRV134UA) or DIP (DRV134PA) packages are recommended. Under these conditions, such as loads greater than 600Ω or very long cables, performance may be degraded in the SO-8 (DRV135UA) package.

## LAYOUT CONSIDERATIONS

A driver/receiver balanced-pair (such as the DRV134 and INA137) rejects the voltage differences between the grounds at each end of the cable, which can be caused by ground currents, supply variations, etc. In addition to proper bypassing, the suggestions below should be followed to achieve optimal OCMR and noise rejection.

- The DRV134 input should be driven by a low impedance source such as an op amp or buffer.
- As is the case for any single-ended system, the source's common should be connected as close as possible to the DRV134's ground. Any ground offset errors in the source will degrade system performance.
- Symmetry on the outputs should be maintained.
- Shielded twisted-pair cable is recommended for all applications. Physical balance in signal wiring should be maintained. Capacitive differences due to varying wire lengths may result in unequal noise pickup between the pair and degrade OCMR. Follow industry practices for proper system grounding of the cables.

**PACKAGING INFORMATION**

Orderable Device	Status <sup>(1)</sup>	Package Type	Package Drawing	Pins	Package Qty	Eco Plan <sup>(2)</sup>	Lead/Ball Finish	MSL Peak Temp <sup>(3)</sup>
DRV134PA	ACTIVE	PDIP	P	8	50	TBD	CU SNPB	Level-NA-NA-NA
DRV134UA	ACTIVE	SOIC	DW	16	48	TBD	CU NIPDAU	Level-3-220C-168 HR
DRV134UA/1K	ACTIVE	SOIC	DW	16	1000	TBD	CU NIPDAU	Level-3-220C-168 HR
DRV135UA	ACTIVE	SOIC	D	8	100	TBD	CU NIPDAU	Level-3-220C-168 HR
DRV135UA/2K5	ACTIVE	SOIC	D	8	2500	TBD	CU NIPDAU	Level-3-220C-168 HR

<sup>(1)</sup> The marketing status values are defined as follows:

**ACTIVE:** Product device recommended for new designs.

**LIFEBUY:** TI has announced that the device will be discontinued, and a lifetime-buy period is in effect.

**NRND:** Not recommended for new designs. Device is in production to support existing customers, but TI does not recommend using this part in a new design.

**PREVIEW:** Device has been announced but is not in production. Samples may or may not be available.

**OBsolete:** TI has discontinued the production of the device.

<sup>(2)</sup> Eco Plan - The planned eco-friendly classification: Pb-Free (RoHS) or Green (RoHS & no Sb/Br) - please check <http://www.ti.com/productcontent> for the latest availability information and additional product content details.

**TBD:** The Pb-Free/Green conversion plan has not been defined.

**Pb-Free (RoHS):** TI's terms "Lead-Free" or "Pb-Free" mean semiconductor products that are compatible with the current RoHS requirements for all 6 substances, including the requirement that lead not exceed 0.1% by weight in homogeneous materials. Where designed to be soldered at high temperatures, TI Pb-Free products are suitable for use in specified lead-free processes.

**Green (RoHS & no Sb/Br):** TI defines "Green" to mean Pb-Free (RoHS compatible), and free of Bromine (Br) and Antimony (Sb) based flame retardants (Br or Sb do not exceed 0.1% by weight in homogeneous material)

<sup>(3)</sup> MSL, Peak Temp. -- The Moisture Sensitivity Level rating according to the JEDEC industry standard classifications, and peak solder temperature.

**Important Information and Disclaimer:**The information provided on this page represents TI's knowledge and belief as of the date that it is provided. TI bases its knowledge and belief on information provided by third parties, and makes no representation or warranty as to the accuracy of such information. Efforts are underway to better integrate information from third parties. TI has taken and continues to take reasonable steps to provide representative and accurate information but may not have conducted destructive testing or chemical analysis on incoming materials and chemicals. TI and TI suppliers consider certain information to be proprietary, and thus CAS numbers and other limited information may not be available for release.

In no event shall TI's liability arising out of such information exceed the total purchase price of the TI part(s) at issue in this document sold by TI to Customer on an annual basis.

## IMPORTANT NOTICE

Texas Instruments Incorporated and its subsidiaries (TI) reserve the right to make corrections, modifications, enhancements, improvements, and other changes to its products and services at any time and to discontinue any product or service without notice. Customers should obtain the latest relevant information before placing orders and should verify that such information is current and complete. All products are sold subject to TI's terms and conditions of sale supplied at the time of order acknowledgment.

TI warrants performance of its hardware products to the specifications applicable at the time of sale in accordance with TI's standard warranty. Testing and other quality control techniques are used to the extent TI deems necessary to support this warranty. Except where mandated by government requirements, testing of all parameters of each product is not necessarily performed.

TI assumes no liability for applications assistance or customer product design. Customers are responsible for their products and applications using TI components. To minimize the risks associated with customer products and applications, customers should provide adequate design and operating safeguards.

TI does not warrant or represent that any license, either express or implied, is granted under any TI patent right, copyright, mask work right, or other TI intellectual property right relating to any combination, machine, or process in which TI products or services are used. Information published by TI regarding third-party products or services does not constitute a license from TI to use such products or services or a warranty or endorsement thereof. Use of such information may require a license from a third party under the patents or other intellectual property of the third party, or a license from TI under the patents or other intellectual property of TI.

Reproduction of information in TI data books or data sheets is permissible only if reproduction is without alteration and is accompanied by all associated warranties, conditions, limitations, and notices. Reproduction of this information with alteration is an unfair and deceptive business practice. TI is not responsible or liable for such altered documentation.

Resale of TI products or services with statements different from or beyond the parameters stated by TI for that product or service voids all express and any implied warranties for the associated TI product or service and is an unfair and deceptive business practice. TI is not responsible or liable for any such statements.

Following are URLs where you can obtain information on other Texas Instruments products and application solutions:

<b>Products</b>		<b>Applications</b>	
Amplifiers	<a href="http://amplifier.ti.com">amplifier.ti.com</a>	Audio	<a href="http://www.ti.com/audio">www.ti.com/audio</a>
Data Converters	<a href="http://dataconverter.ti.com">dataconverter.ti.com</a>	Automotive	<a href="http://www.ti.com/automotive">www.ti.com/automotive</a>
DSP	<a href="http://dsp.ti.com">dsp.ti.com</a>	Broadband	<a href="http://www.ti.com/broadband">www.ti.com/broadband</a>
Interface	<a href="http://interface.ti.com">interface.ti.com</a>	Digital Control	<a href="http://www.ti.com/digitalcontrol">www.ti.com/digitalcontrol</a>
Logic	<a href="http://logic.ti.com">logic.ti.com</a>	Military	<a href="http://www.ti.com/military">www.ti.com/military</a>
Power Mgmt	<a href="http://power.ti.com">power.ti.com</a>	Optical Networking	<a href="http://www.ti.com/opticalnetwork">www.ti.com/opticalnetwork</a>
Microcontrollers	<a href="http://microcontroller.ti.com">microcontroller.ti.com</a>	Security	<a href="http://www.ti.com/security">www.ti.com/security</a>
		Telephony	<a href="http://www.ti.com/telephony">www.ti.com/telephony</a>
		Video & Imaging	<a href="http://www.ti.com/video">www.ti.com/video</a>
		Wireless	<a href="http://www.ti.com/wireless">www.ti.com/wireless</a>

Mailing Address: Texas Instruments  
Post Office Box 655303 Dallas, Texas 75265